



DILE

a t i k a

Atika es la silla operativa que representa el impulso, la renovación y la adaptación a las exigencias de los nuevos entornos corporativos: más ligeros, más eficientes, más productivos...mejores. Redefine la palabra ergonomía con las máximas prestaciones del mercado.



atika malla



¡MUY IMPORTANTE! 
El soporte lumbar regulable es un accesorio que hay que añadir a la referencia base.

atika malla



atika malla



8d

Silla alta malla sin brazos | S0000-12bb-xyy

Referencia	Base	Respaldo malla	Ruedas	Mecanismo
S2711*	nylon negro	regulable	nylon/goma	sincro
S2705	aluminio pulido	regulable	romo/goma	sincro
S2710	nylon negro	regulable	nylon/goma	sincro desplazador
S2704	aluminio pulido	regulable	romo/goma	sincro desplazador

*Para esta Referencia en cualquiera de sus acabados (ver páginas de tejidos disponibles), DILE se compromete a la fabricación en un plazo máximo de **8 días**. Transcurridas las 24 horas no se admitirá modificación alguna ni anulación del pedido.

Unidades 1 / Tela cliente 75 cm / Peso 20 Kg / Volumen 0,17 m³

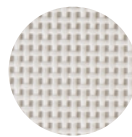

01 / Blanco

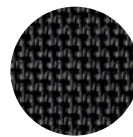

02 / Negro

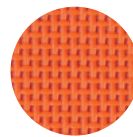

06 / Naranja

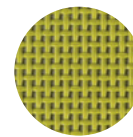

20 / Verde

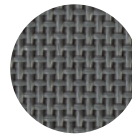

22 / Gris

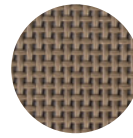

26 / Marrón

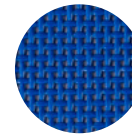

27 / Azul

color respaldo malla (xx)	
01	blanco
02	negro
06	naranja
20	verde
22	gris
26	marrón
27	azul



atika tapizada



atika tapizada



Silla alta tapizada sin brazos | S0000-01bb-xyyy

Referencia	Base	Respaldo tapizado	Ruedas	Mecanismo
S2200	nylon negro	regulable	nylon/goma	sincro
S2206	aluminio pulido	regulable	romo/goma	sincro
S2201	nylon negro	regulable	nylon/goma	sincro desplazador
S2207	aluminio pulido	regulable	romo/goma	sincro desplazador

Unidades 1 / Tela cliente 95 cm / Peso 20 Kg / Volumen 0,17 m³



B01 / Negro

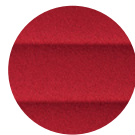

B02 / Rojo

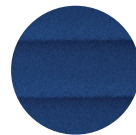

B03 / Azul

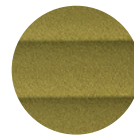

B04 / Verde

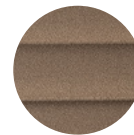

B05 / Arena

color respaldo (xx)	
B01	negro
B02	rojo
B03	azul
B04	verde
B05	arena



a t i k a a t i o k n a p p e r m e e n t o s



Accesorios

Referencia	Características
S2715 (A)	Cabecero negro regulable tapizado
S2716 (B)	Cabecero fijo poliuretano negro
S2270	Perchero cromado
S9213 (C)	Soporte lumbar regulable
K9202 (D)	Kit conversión taburete nylon con ruedas
K9203 (D)	Kit conversión taburete nylon con tapones
K9210 (D)	Kit conversión taburete aluminio con tapones
K9211 (D)	Kit conversión taburete aluminio con ruedas

(A)/(B) El cabecero debe ir acompañado de la silla, no se vende suelto.

(A) El cabecero ha de ir con el mismo tapizado que el asiento.

(C) El soporte lumbar regulable debe ir acompañado de la silla, no se vende suelto.

(D) Incluye aro, resorte gas alto, tapones o ruedas (dependiendo referencia seleccionada).

Referencia	Características
A004	Entrega silla semimontada
A006	Entrega silla montada

Brazos opcionales

Referencia	BR02	BR23	BR26	BR03	BR04
Características	1D	1D	2D	3D	4D

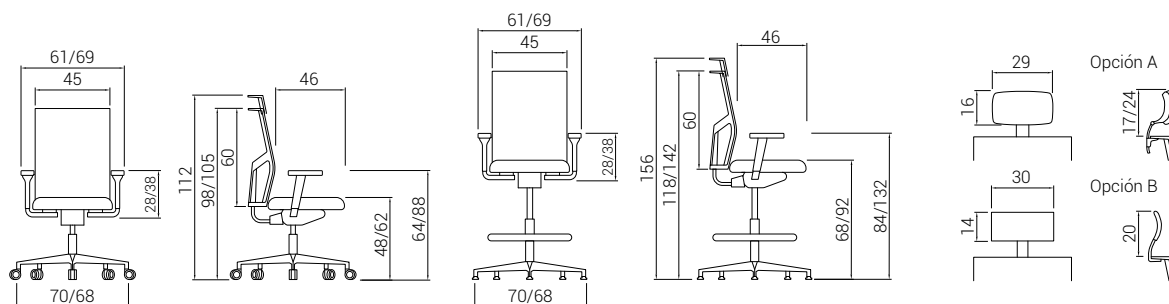

120kg Peso máximo

CERTIFICADOS Y NORMATIVAS

UNE EN 1335-1:2021, UNE EN 1335-2:2019

UNE EN 89401-01